



# GROWING UP ON ICE



**GRADES  
6 - 8**



# **STUDENT HANDOUTS (PRINT PER CLASS)**

# TEAM B-030





# **STUDENT HANDOUTS (PRINT PER SMALL GROUP)**

# ANTARCTICA FACT SHEET

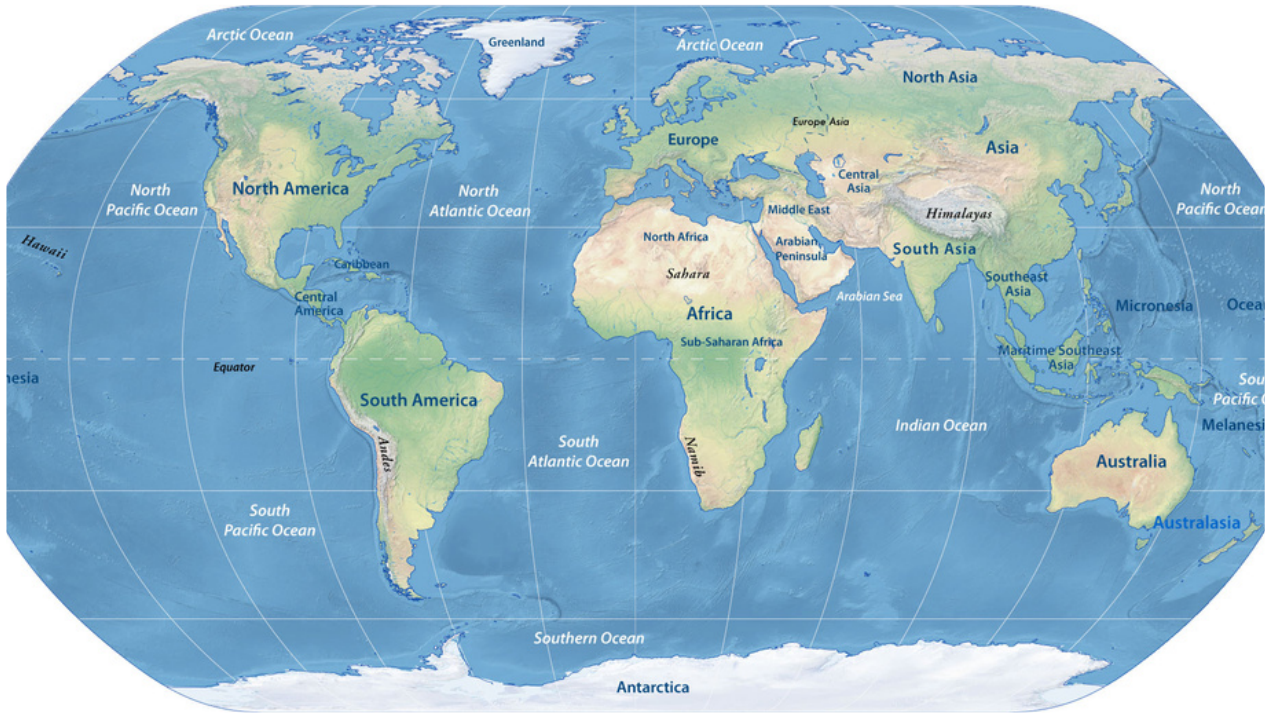

## ENVIRONMENTAL CONDITIONS

### EXTREME ICE



About 97.6 percent of Antarctica is ice that has formed over millions of years. This ice contributes 90 percent of all the world's ice and 70 percent of all the world's fresh water.

### EXTREME WIND



Antarctica is the windiest place on Earth. Wind speeds in Antarctica can reach up to 218 miles per hour. (In the U.S., daily wind speeds typically average between 6 and 12 miles per hour.)

### EXTREME COLD



Antarctica is the coldest place on Earth. Winter temperatures range from  $-128.6^{\circ}\text{F}$  on the high inland ice sheet to  $-76^{\circ}\text{F}$  near sea level ( $32^{\circ}\text{F}$  is considered freezing).

# CHALLENGE GUIDELINES

## THINGS TO AVOID



- Frightening or injuring the Weddell seal mother and pup
- Injuring any member of your team
- Damaging your team's research equipment

## THINGS TO CONSIDER



- Remember to use the unique skills and training of your team members to your advantage
- Snow can serve to insulate the ice from the air temperature, but also weighs down the ice and can hide dangerous cracks
- Exposing your skin to cold, windy weather increases your likelihood of injury caused by freezing of the skin and underlying tissues

# CHALLENGE GUIDELINES

## AVAILABLE EQUIPMENT



### **PistenBully**

Large, tracked vehicle with an enclosed cab (max speed 5 mph)



### **Cooler**

An insulated container



### **Heat Packs**

Bags containing a substance that gives off heat



### **Snowmobile**

Small, open cab vehicle (max speed 45 mph)

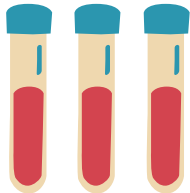

### **Vacutainers**

Glass vacuum sealed test tubes



### **PPE**

Personal Protective Equipment (PPE) such as snow bibs, goggles, gloves, etc.

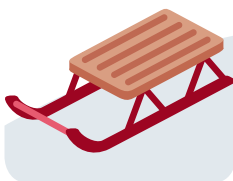

### **Snow Sled**

A land vehicle that can hold passengers as it slides across a surface, usually of ice or snow



### **Herding Boards**

Protective equipment for blocking an animal's movement or view

# EXTREME ICE CHALLENGE

About 97.6 percent of Antarctica is ice that has formed over millions of years. This ice contributes 90 percent of all the world's ice and 70 percent of all the world's fresh water. Antarctica's sea ice forms, expands, and melts in the ocean. Fast ice is a specific type of ice that is attached to the coastline or shallow sea floor and does not drift with ocean currents and wind. This type of ice usually starts to grow in fall and melts away completely during the summer. In spring, Weddell seals will breed and care for their pups on the spring fast ice to avoid predators such as orcas and leopard seals. Both orcas and leopard seals have been observed in the waters around McMurdo Station in the summer, after the sea ice has broken up.

In recent years, as the world warms due to climate change, the fast ice has broken out and melted earlier. This change in the environment has provided predators access to vulnerable, young Weddell seal pups, before they can dive and forage on their own. This has also become problematic for researchers who must travel across the ice to observe and research Weddell seals in the wild. Understanding the dynamics of sea ice movements and cracks is critical when working with seals.

Today, you have arrived at your field research site with your team. Two seals have been spotted nearly one mile away from your field research site. You will have to come up with a plan to safely navigate across the fast ice with your team to observe a Weddell seal mother and her pup. **How will you safely navigate across the ice to observe the two seals? What will you do if you encounter a crack in the ice, with no way around it?**

PHOTOS WERE TAKEN UNDER THE NMFS PERMITS 17441-00, 87-1851, AND 21006





# EXTREME WIND CHALLENGE

Antarctica is the windiest place on Earth. Wind speeds in Antarctica can reach up to 218 mph. (In the United States, daily wind speeds typically average between 6 and 12 miles per hour.) Weddell seals are well insulated from the cold, even in these extreme, windy conditions! Pups often rest downwind from their moms to stay warm.

Researchers can use Apple huts (large field shelters) to move themselves and seals out of the wind to perform successful body measurements and muscle and blood sampling in less-than-ideal weather. But not all field sites have Apple huts available or nearby. Sometimes researchers have to get creative with their people and equipment to find a solution.

In order to collect this data set, your team will need to safely and briefly capture a Weddell seal pup named Kit Kat. However, her mother is also nearby. Kit Kat is a spirited pup, who earned her name because she doesn't give researchers a break! She likes to climb on her mom, and she tends to hang out close to the sea ice cracks. Your research permits require that this work is done as efficiently as possible to minimize disturbance to the animals and maintain the safety of the research team and animals at all times. **How will you safely distract the mother and capture the pup for sample collection? How do you plan to protect your team and equipment from the extreme winds during this process?**

PHOTOS WERE TAKEN UNDER THE NMFS PERMITS 17441-00, 87-1851, AND 21006  
PHOTO OF FLUFFY PUP BY EMMA WEITZNER



# EXTREME COLD CHALLENGE

Despite rising temperatures due to climate change, Antarctica is the coldest place on Earth. Winter temperatures range from  $-128.6^{\circ}\text{F}$  on the high inland ice sheet to  $-76^{\circ}\text{F}$  near sea level. ( $32^{\circ}\text{F}$  is considered freezing.) Weddell seals are particularly equipped to handle below freezing temperatures thanks to their blubber (fat) and thick fur coats. On the other hand, the extreme cold is a difficult place for researchers to live comfortably and conduct their research. Research equipment can easily malfunction in the cold, and in weather below  $-4^{\circ}\text{F}$  (which is not uncommon) syringes will instantly freeze and crack if not handled properly.

McMurdo Station serves as a logistics hub for the U.S. Antarctic Program and is the safest location to complete sample analysis indoors and out of the cold. The station not only has labs onsite, but unlike the spring fast ice that pups are on, the station is built on secure bare volcanic rock.

Today, your team must transport the Weddell seal blood and tissue samples back to the lab for analysis. But to do that, you must travel across the sea ice and protect your team against the extreme cold. **What will you use to safely warm, support, and protect samples and your team as you travel across the ice? How will you ensure that your samples will not freeze or crack from the cold or rough icy terrain?**

PHOTOS WERE TAKEN UNDER THE NMFS PERMITS 17441-00, 87-1851, AND 21006  
PHOTO OF MACARONI NURSING BY LINNEA PEARSON



# FIELD BIOLOGIST

## CAREER PROFILE

### **Description**

Field biologists study living organisms such as plants and animals in their natural environments by observing the behavior of animals and the relationship they have to their environment. Their work often includes developing research studies, collecting and analyzing scientific data, and publishing research to communicate their findings.

### **Desired Skills**

- can notice slight changes in people or the environment
- use logic and reason to draw conclusions
- can endure extended periods of time in harsh or isolated environments
- enjoy working with a small team



### **Work Environment**

Most work takes place in the field with a team, making scientific observations and collecting samples. However, occasional trips to McMurdo Station are needed to deliver and further analyze specimens.

# FIELD BIOLOGIST

## CAREER PROFILE



***Field biologists hold a degree in subjects such as:***

- Marine biology
- Plant biology
- Animal behavior
- Ecology
- Evolutionary biology
- Neurobiology
- Molecular biology

<b>Possible Job Titles</b>	<b>Recommended Schooling/Experience</b>
Student Researcher	No college degree is needed, but prior experience in laboratories and performing research while earning a college degree is required
Research Assistant	Associate degree (2 years of college) acceptable, but bachelor's degree (4 years of college) is preferred
Marine Biologists	Bachelor's degree (4 years of college) acceptable, but master's degree (6+ years of college) is preferred
Principal Investigator	Bachelor's degree (4 years of college) and master's degree (6+ years of college) acceptable, but doctoral degree (3+ years of study) is preferred

# VETERINARY SCIENTIST

## CAREER PROFILE

### **Description**

Veterinary scientists conduct research on animal medicine and animal health conditions. This often includes caring for animals hands-on, developing research studies, collecting and analyzing scientific data, and publishing research to communicate their findings.

### **Desired Skills**

- experience working with animals
- can notice slight changes in animal behavior or the environment
- use logic and reason to draw conclusions
- can endure extended periods of time in harsh or isolated environments
- enjoy working with a small team



### **Work Environment**

Most work takes place in the field with a team, making scientific observations and collecting samples. However, occasional trips to McMurdo Station are needed to deliver and further analyze specimens.

# VETERINARY SCIENTIST

## CAREER PROFILE



***Veterinary scientists hold a degree or certification in subjects such as:***

- Biology
- Zoology
- Animal science
- Veterinary science
- Veterinary medicine
- Veterinary medicine and surgery

<b>Possible Job Titles</b>	<b>Recommended Schooling/Experience</b>
Animal Care and Service Worker	No college degree is needed but prior experience volunteering or working with animals is preferred
Veterinary Assistant	No college degree is needed but an associate degree (2 years of college) is preferred
Veterinary Technician	Associate degree (2 years of college) acceptable, but bachelor's degree (4 years of college) is preferred
Veterinarian	Bachelor's degree (4 years of college) and veterinary school (4 additional years of specialized training)

# ENGINEER

## CAREER PROFILE

### **Description**

Engineers support researchers through installing and maintaining research equipment that is needed to carry out research safely and accurately. This often includes tools that scientists will use for the collection and analysis of scientific data, such as technology, mechanical equipment, transport vehicles, housing, and more!

### **Desired Skills**

- ability to creatively solve problems
- enjoy learning how to use modern technologies
- great attention to detail
- can work independently and with others
- willingness to follow strict safety guidelines



### **Work Environment**

Most work takes place at McMurdo Station with a team, but there may be occasional trips out to the field to support scientists as they live and work in the field observing, collecting, and delivering specimens to McMurdo Station.

# ENGINEER

## CAREER PROFILE



***Engineers hold a degree or certification in subjects such as:***

- Biomedical engineering
- Chemical engineering
- Computer engineering
- Electrical engineering
- Health and safety engineering
- Industrial engineering
- Mechanical engineering

<b>Possible Job Titles</b>	<b>Recommended Schooling/Experience</b>
Mechanic	Trade school or associate degree (2 years of college) is required
Engineer	Associate degree (2 years of college) is required, but bachelor's degree (4 years of college) is preferred
Engineering Coordinator	Bachelor's degree (4 years of college) is acceptable, but master's degree (6+ years of college) is preferred
Engineering Supervisor	Bachelor's degree (4 years of college) is acceptable, but master's degree (6+ years of college) is preferred



# CLINICAL LAB SCIENTIST

## CAREER PROFILE

### **Description**

Following strict health and safety procedures, clinical lab scientists collect samples and perform tests using technical equipment to analyze hazardous chemicals, body fluids and tissue, biological waste, and other substances.

### **Desired Skills**

- enjoy working hands-on when solving puzzles and problems
- great attention to detail
- capable of working on several projects at once
- can work independently and with others
- willingness to follow strict safety guidelines



### **Work Environment**

Most work takes place in a laboratory at McMurdo Station with a team, but there may be occasional trips out to the field to collect or deliver specimens or to take measurements.

# CLINICAL LAB SCIENTIST

## CAREER PROFILE



***Clinical lab scientists hold a degree in subjects such as:***

- Biology
- Biomedical science
- Biotechnology
- Chemistry
- Environmental science
- Forensic science
- Pharmacology
- Physics

<b>Possible Job Titles</b>	<b>Recommended Schooling/Experience</b>
Assistant Lab Technician	No college degree is needed but an associate degree (2 years of college) is preferred
Lab Technician	Bachelor's degree (4 years of college) is acceptable
Lead Lab Technician	Bachelor's degree (4 years of college) is acceptable
Laboratory Manager	Bachelor's degree (4 years of college) is acceptable, but master's degree (6+ years of college) is preferred

# STATION SUPPORT

## CAREER PROFILE

### **Description**

There is an extensive support network of support behind all research that occurs in Antarctica from the food teams eat to the equipment they use to the safety training and policies they participate in.

### **Desired Skills**

- ability to creatively solve problems
- great attention to detail
- can work independently and with others
- can endure extended periods of time in harsh or isolated environments
- willingness to uphold strict safety guidelines and take responsibility for the safety of others



### **Work Environment**

Most work takes place at McMurdo Station with a team, but there may be occasional trips out to the field to support scientists as they live and work in the field observing, collecting, and delivering specimens to McMurdo Station.

# STATION SUPPORT

## CAREER PROFILE



***Individuals who support scientific research hold a degree or certification in subjects such as:***

- Outdoor education
- Adult education
- Wilderness first aid
- Incident command structure
- Leadership

Possible Job Titles	Recommended Schooling/Experience
Station Leader	No college degree is needed but an associate degree (2 years of college) or bachelor's degree (4 years of college) is preferred
Station Supply Officer	No college degree is needed but an associate degree (2 years of college) or specialized training is preferred
Watercraft Operator	No college degree is needed but an associate degree (2 years of college) or specialized training is preferred
Field Training Officer	No college degree is needed but a bachelor's degree (4 years of college) is preferred and wilderness first aid certifications are required

# PACIFIC HARBOR SEAL FACT SHEET

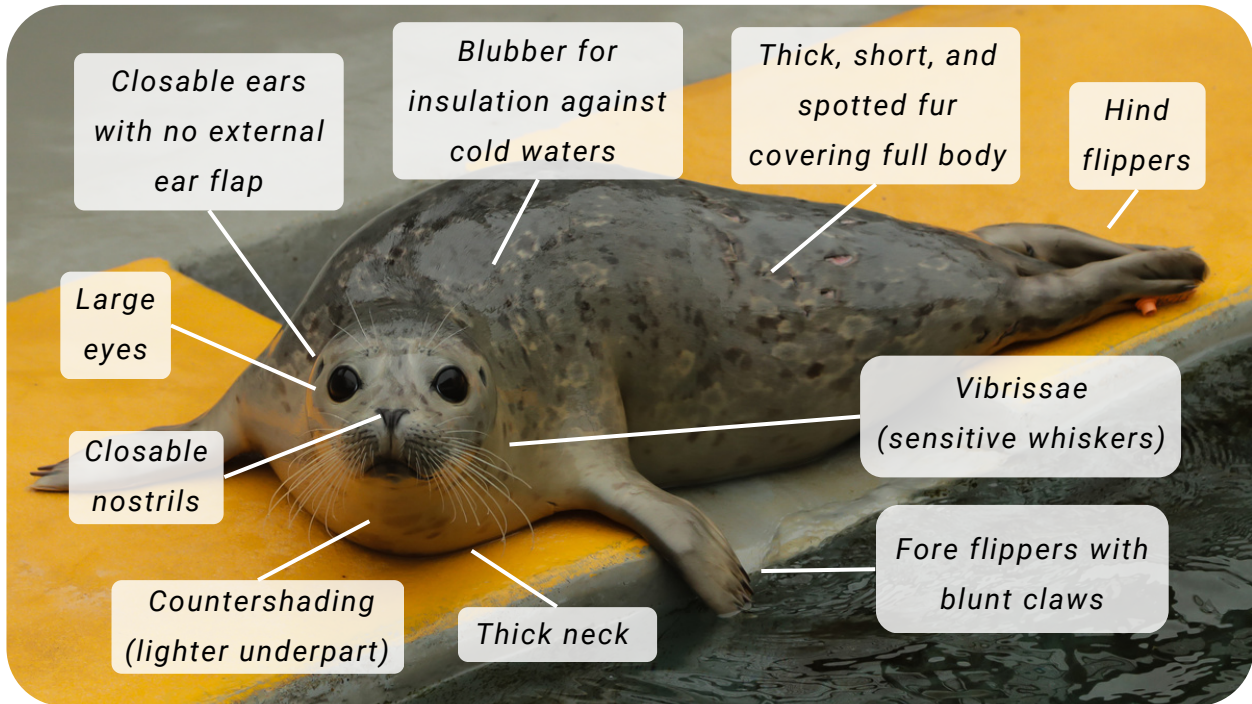

## HABITAT & BEHAVIOR

Pacific harbor seals are found north of the equator in both the Atlantic and Pacific oceans. In the Pacific, they can be found in areas ranging from Alaska to Baja California, Mexico.



Harbor seals live in coastal habitats. They use rocks, beaches, and floating ice to haul out when they are not traveling and/or foraging at sea. Harbor seals haul out on land to rest, regulate temperature, interact, give birth, nurse pups, and avoid predators.

# WEDDELL SEAL FACT SHEET

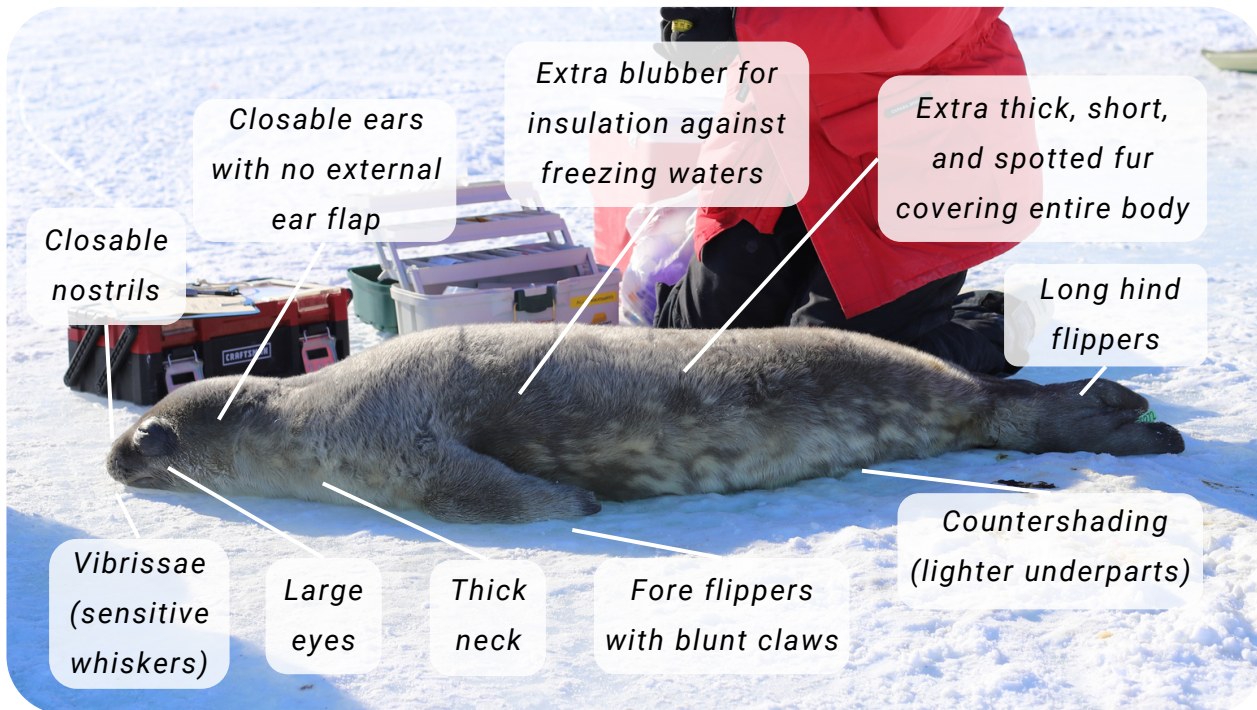

## HABITAT & BEHAVIOR



Weddell seals live all around Antarctica and stay mostly near the “fast ice” – the ice that is attached to the land. They are safer there than on the “pack ice” – the ice that flows near the water. Their main predator, the killer whale is less able to hold its breath for long enough periods to reach the fast ice.

Weddell seals haul out on the fast ice to rest, regulate temperature, interact, give birth, nurse pups, and avoid predators.



# TIME-DEPTH COMPARISON

## DURATION (time in minutes)

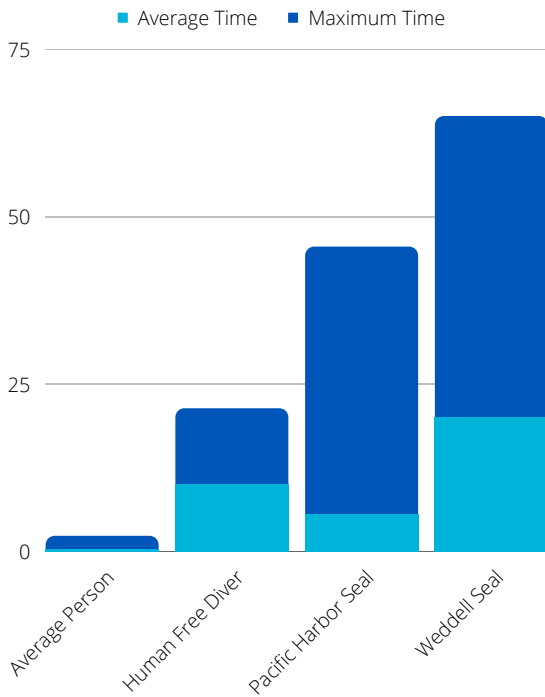

## DEPTH (meters)

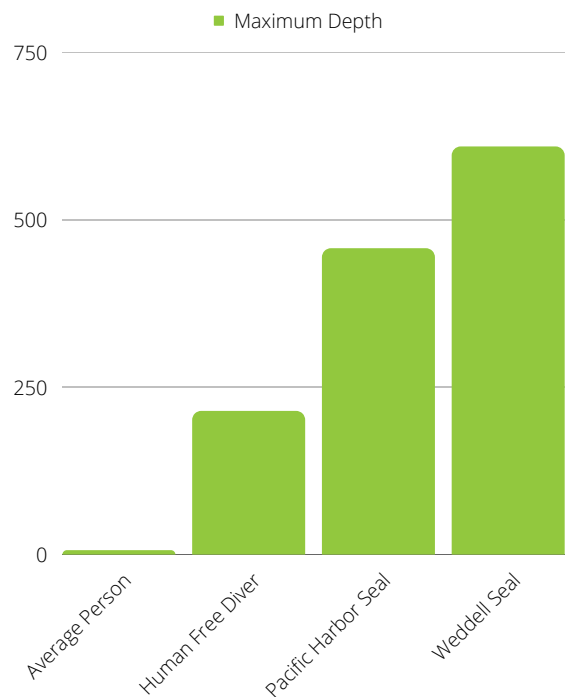

# COMPARISON OF STORED OXYGEN DISTRIBUTION

## HUMANS

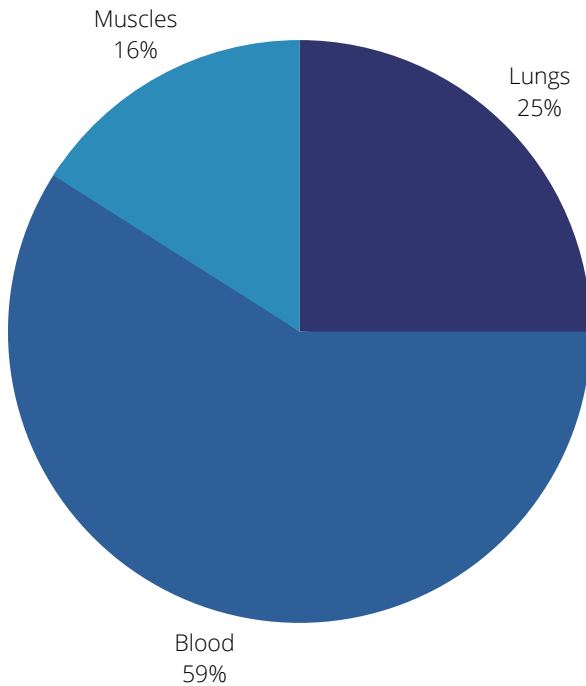

## NORTHERN ELEPHANT SEAL

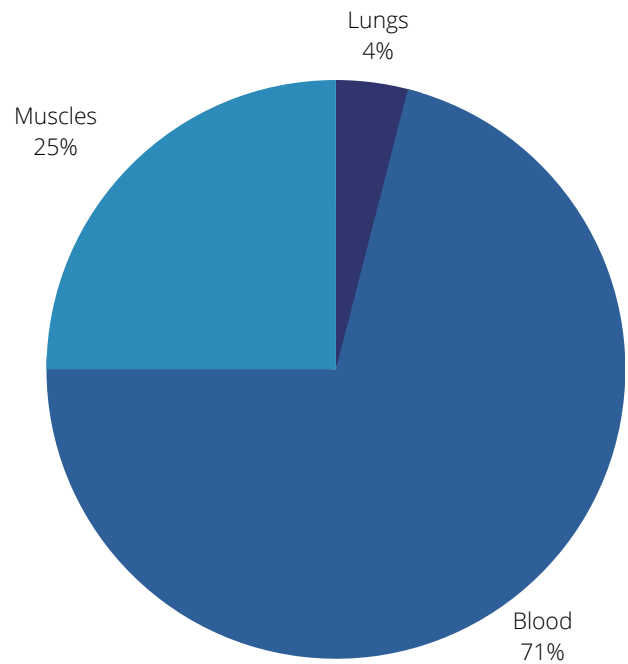

## SIZE COMPARISON

A fully grown northern elephant seal male can reach lengths of over 13 feet and can weigh nearly 4,400 pounds!





# RBC COUNT PROTOCOL

## DIRECTIONS

Follow the protocol on the next page to count Kit Kat's red blood cells (RBC) for Week 1. Use both sides of the hemocytometer (Chamber 1 and Chamber 2) during your blood sample analysis. Record all calculations on your Weddell Seal Pup Data Sheet.

## WHAT IS A HEMOCYTOMETER?

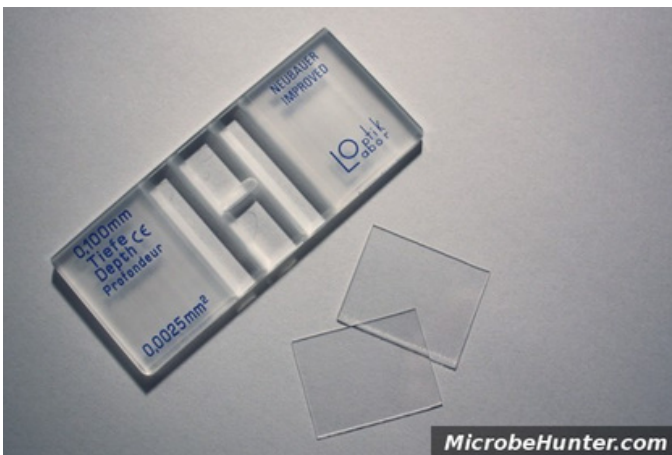

A hemocytometer (or counting chamber) is a specimen slide that is analyzed under a microscope to determine the number of cells in a liquid sample, such as blood.

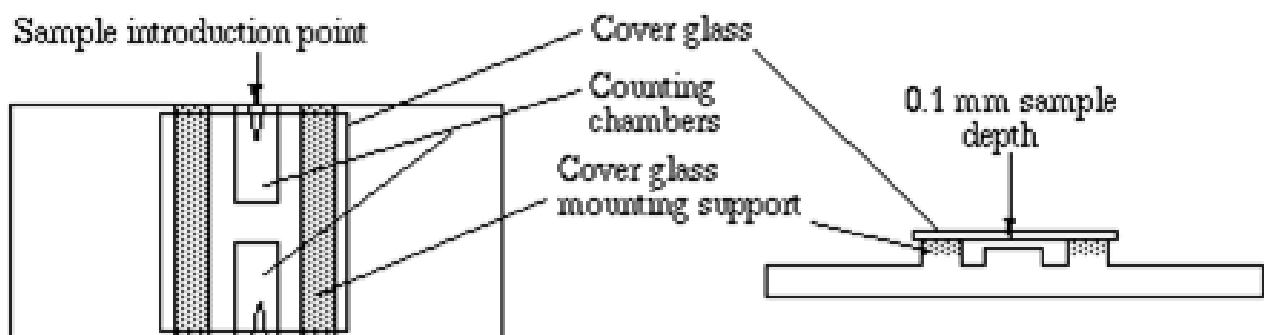

#### REFERENCES:

- BROWN, B.A., HEMATOLOGY: PRINCIPLES AND PROCEDURES. 6TH ED., PHILADELPHIA: LEA AND FEBIGER, 1993.
- RBC DETERMINATION FOR MANUAL METHODS, UNOPETTE MICRO-COLLECTION SYSTEM, PRODUCT CIRCULARS 5804 AND 5853, BECTON-DICKINSON, RUTHERFORD, NJ 07070.

# RBC COUNT PROTOCOL

## Protocol (steps)

1. Count and record the number of red blood cells in each of the 5 numbered squares for Chamber 1. **DO NOT** count unnumbered boxes.
2. Combine the counts for all 5 squares for Chamber 1 and record the total sum.
3. Repeat steps 1-2 for Chamber 2.
4. Combine the total sums of Chamber 1 and Chamber 2, divide by 2 and record the Average RBC.
5. Multiply the Average RBC x 10,000 to get Kit Kat's final RBC count for Week 1.
6. Calculate and fill in the rest of the missing data on the Weddell Seal Pup Data Sheet.

## COUNTING GUIDE

Count the cells that lie on the top and left-hand lines of each square but **DO NOT** count any touching the 3 bottom or 3 right-hand lines.

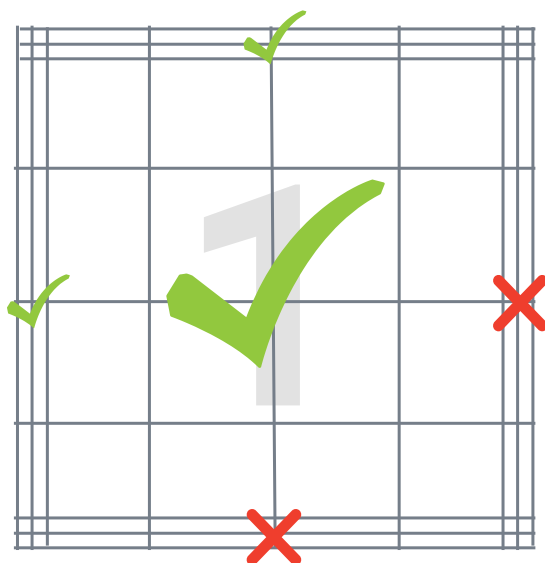
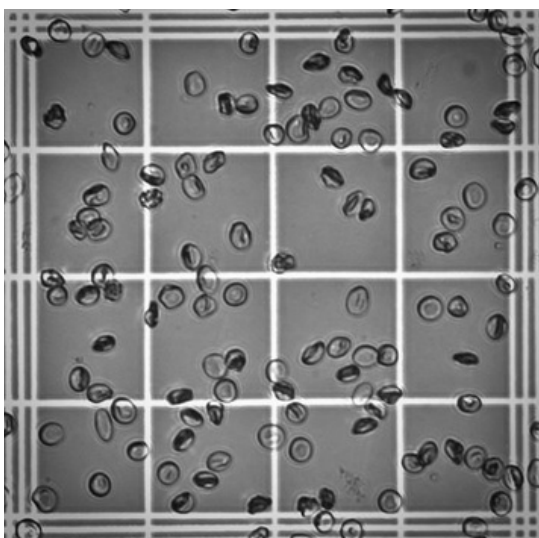

### REFERENCES:

- BROWN, B.A., HEMATOLOGY: PRINCIPLES AND PROCEDURES. 6TH ED., PHILADELPHIA: LEA AND FEBIGER, 1993.
- RBC DETERMINATION FOR MANUAL METHODS, UNOPETTE MICRO-COLLECTION SYSTEM, PRODUCT CIRCULARS 5804 AND 5853, BECTON-DICKINSON, RUTHERFORD, NJ 07070.

# HEMOCYTOMETER CHAMBER 1

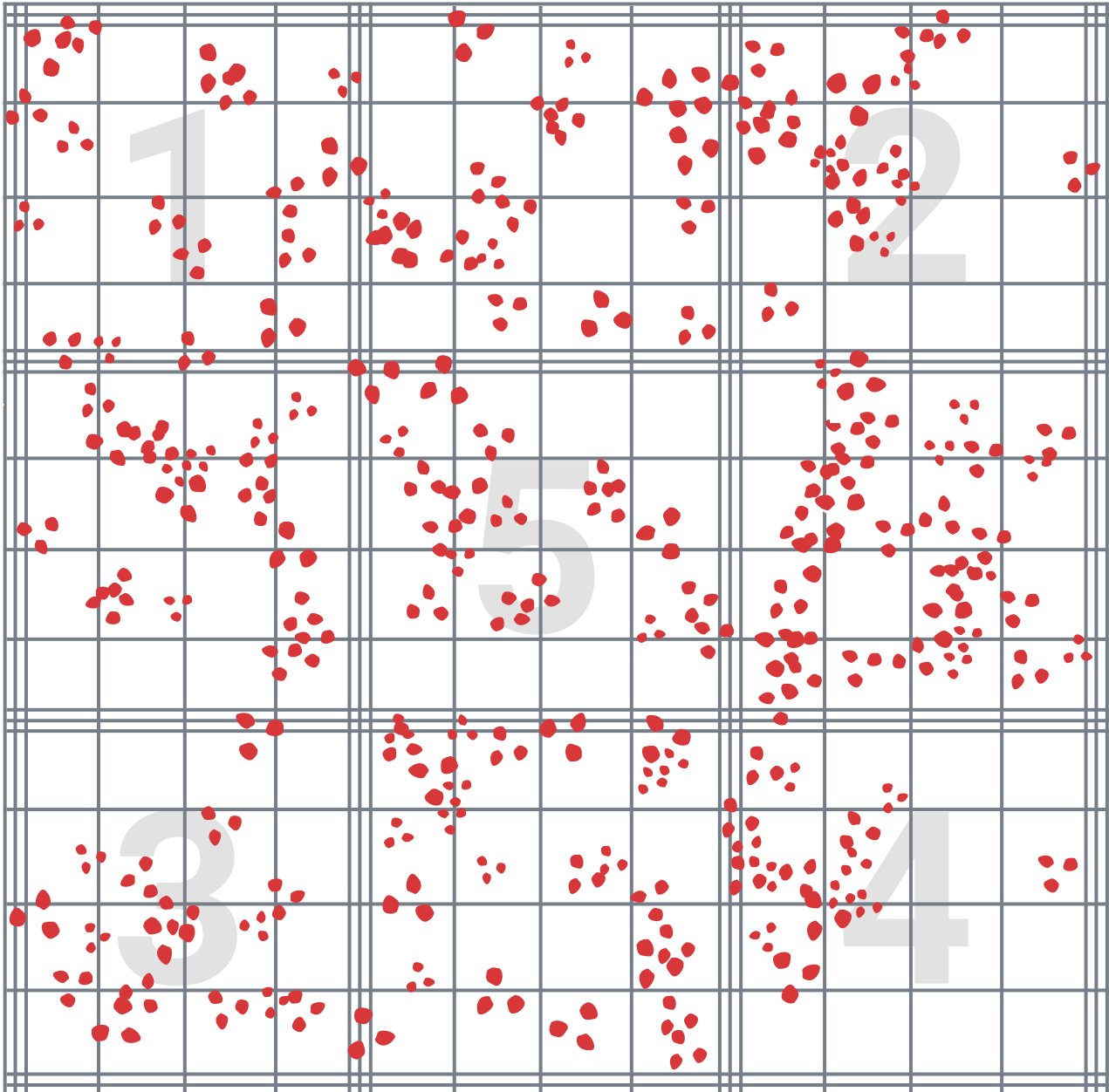

# HEMOCYTOMETER CHAMBER 2

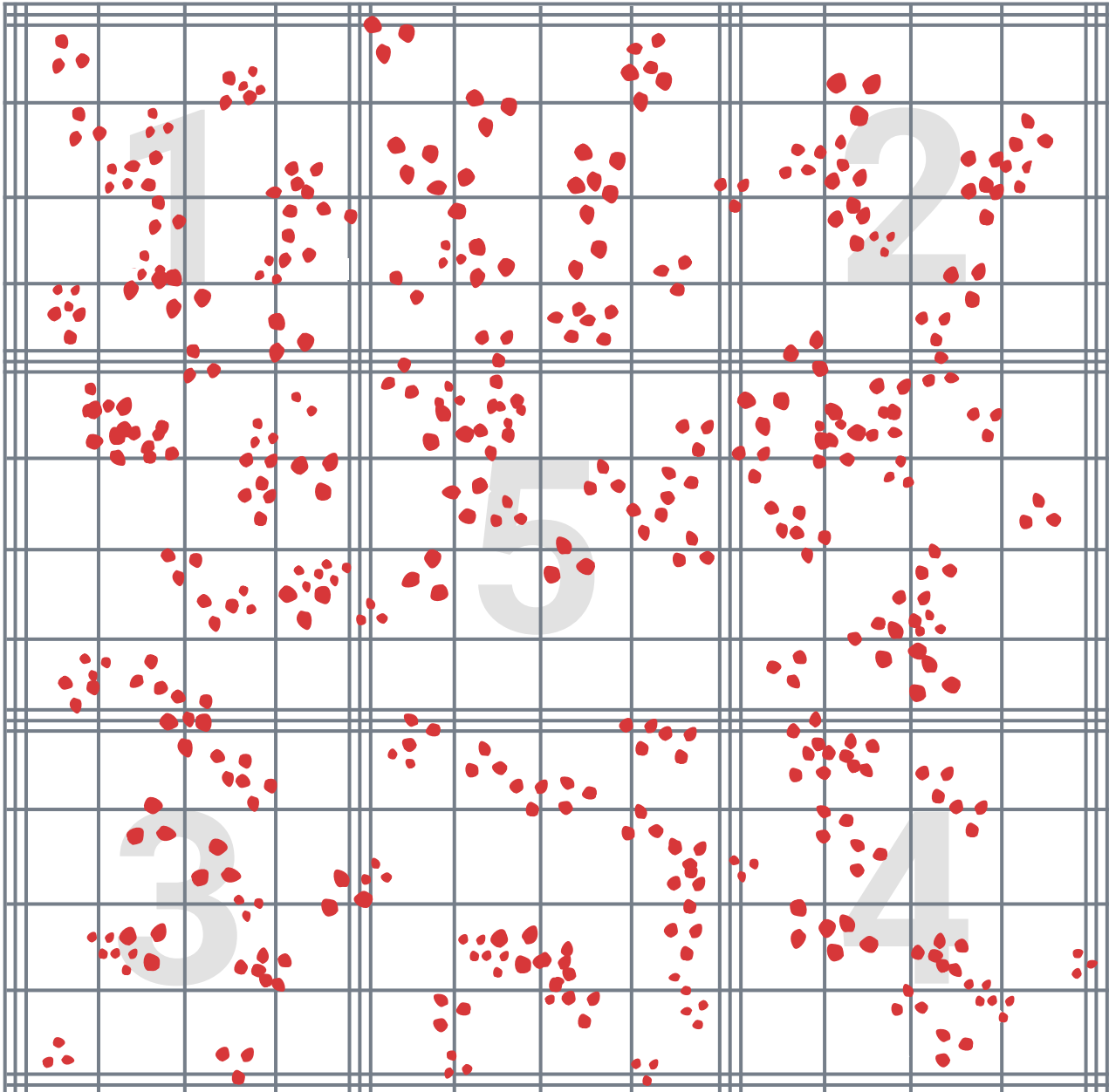



# **STUDENT HANDOUTS (PRINT PER STUDENT)**

# WEDDELL SEAL PUP DATA SHEET

**KIT KAT**



Animal ID: LW1903

Sex: Female

**TABLE 1**

Age (weeks)	Weight (kg)	Total Time in Water (minutes)	Maximum Dive Depth (meters)	Maximum Dive Duration (minutes)	Mean Dive Depth (meters)	Mean Dive Duration (minutes)
1	40.5	3	0	0	0	0
3	66	1127.5	16.629	4	9.321	2.4
5	82.5	1831	20.708	5	9.588	2.4
7	85	553	7.961	10.5	7.961	10.5

**TABLE 2**

Age (weeks)	Chamber	Count 1	Count 2	Count 3	Count 4	Count 5	Sum of Counts	Average RBC (x10,000)
1	1							
	2							
3	1	60	60	67	68	69	324	327
	2	61	71	69	66	63	330	
5	1	76	66	68	65	70		
	2	60	70	56	69	79		
7	1	71	70	68	70	66		
	2	58	58	69	58	70		